

# TP

## TUNNEL PIZZA OVEN



SVEBA DAHLEN



# Versatile and quick for large volumes – no monitoring required

**This tunnel pizza oven is designed to offer great flexibility and efficient pizza baking. The pizza oven is also ideal for baking products such as pies and pita bread, as well as for making dishes such as hamburgers, fish and hot dogs. The oven is extremely energy efficient, quiet, compact and well insulated, providing high capacity in a small space.**

The TP tunnel pizza oven can be easily adapted to the product being baked and the capacity required. The user can choose between three standard widths and up to three sections in height. Oven decks can also be added later if more capacity is needed. The oven is simple to use, and the temperature and baking time can be steplessly set using the easy-to-use control panel. The products do not need to be monitored during the baking time, leaving more time for the customers!

The TP Oven is highly energy efficient thanks to good insulation and infrared heating. The temperatures of the top and bottom heating in the two oven zones are controlled by four temperature sensors. This is combined with rapid temperature regulation and a radiation cover, which enables even baking and products such as pizzas that are on par with their stone oven-baked counterparts.



### Heating system

Turbo function, radiation cover, power guard, dual temperature sensors and high-quality heating elements for an even temperature distribution.



### Energy efficiency

Fully insulated walls, floors and tops keep the heat inside the oven. The heat sources are installed in the oven interior and are powered by direct electricity. This means green use of the energy.



### Control panel

User-friendly, smart control panel that gives the user complete control of the entire baking process.



### Modular design

Decks come in divisible sections which means more sections can be added later on.



### Low noise level

A very quiet oven.



1

SVEBA DAHLEN

4

5

11

7

10

3

## PROPERTIES AND FUNCTIONALITY

The TP Oven is designed for operating temperatures of up to 400°C. Its high capacity makes it possible to bake, for example, up to 500 pizzas per hour depending on the baking time. The pizzas are baked quickly, retain all of their flavor, and get a crispy crust without the filling drying out. This result is achieved by using infrared heat only and avoiding the use of fans.

### 1. Steam canopy at infeed and outfeed

Creates a good working environment (not on TP10, TP20, TP30).

### 2. Stepless adjustment of top and bottom heating

Stepless adjustment of baking time between 2 and 15 minutes which means just a short step from pizza and pie baking to other types of cooking. The oven can be easily used to cook foods such as hot dogs, vegetables or tapas.

### 3. Aluminum legs with wheels.

Make it easier to move the oven. Adjustable for tabletop use of TP10, TP20, TP30.

### 4. Three standard widths

Expandable with up to three sections in height. Suitable for most pizza sizes.

### 5. Stainless steel exterior and well-insulated oven chamber

Keeps the heat inside and maintains a lower temperature on the outside.

### 6. Digital panel

Provides good control and makes it easy to set the right time and adjust the temperature up to 400°C in two zones per oven chamber.

- 5 program settings.
- Energy-saving mode.
- Weekly timer – individual start time for each weekday.
- Clear and easy-to-read touchscreen.
- Choice of user language on the screen.



### 7. Oven chamber with two different zones

The temperatures of the top and bottom heating are controlled separately for each zone, resulting in even baking.

### 8. Energy-saving mode

Can be activated when the oven is not in use, which saves money and reduces environmental impact.

### 9. Turbo function

Provides quick heating and quickly sets the correct temperature.

### 10. Removable collection tray

For any crumbs.

### 11. Stainless steel mesh conveyor

### 12. Outfeed tray for products

We are working on certifying our products.  
Contact your dealer for the latest certification information.

# TECHNICAL SPECIFICATION

## TP10/TP20/TP30

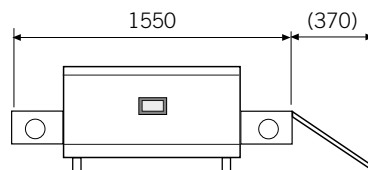
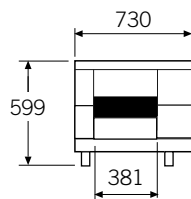

**TP10**  
W x H: 730 x 599 mm  
D: 1,920 mm

**TP20**  
W x H: 730 x 939 mm  
D: 1,550 mm

**TP30**  
W x H: 730 x 1,279 mm  
D: 1,550 mm

Can be ordered with one, two or three decks, TP10, TP20, TP30.  
The indicated heights are when the adjustable feet are in the shortest position.  
The feet can be adjusted up to 38 mm.

## TP11/TP12

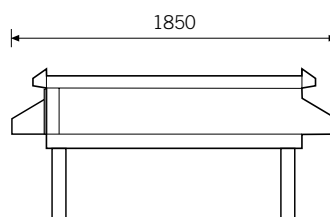
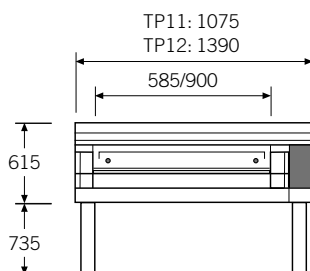

**TP11**  
W x H: 1,075 x 1,350 mm  
D: 1,850 mm

**TP12**  
W x H: 1,390 x 1,350 mm  
D: 1,850 mm

## TP21/TP22

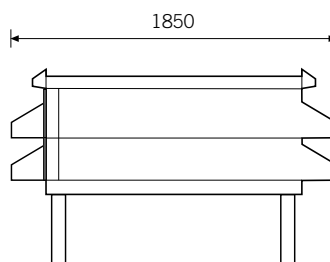
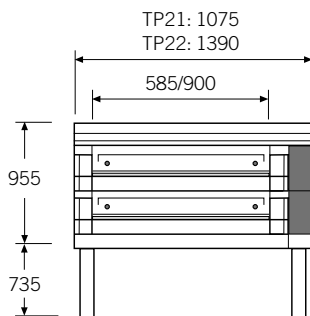

**TP21**  
W x H: 1,075 x 1,690 mm  
D: 1,850 mm

**TP22**  
W x H: 1,390 x 1,690 mm  
D: 1,850 mm

## TP31/TP32

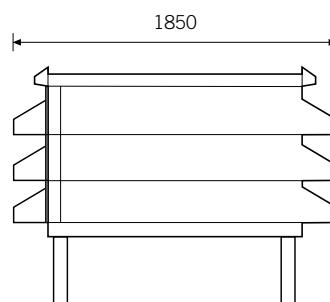
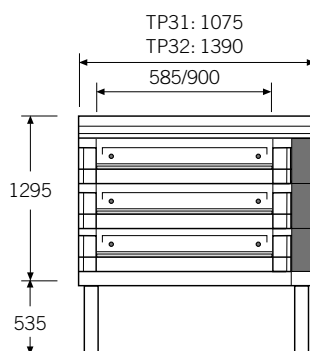

**TP31**  
W x H: 1,075 x 1,830 mm  
D: 1,850 mm

**TP32**  
W x H: 1,390 x 1,830 mm  
D: 1,850 mm

	<b>TP10 - 1 deck</b>	<b>TP20 - 2 decks</b>	<b>TP30 - 3 decks</b>
Conveyor W × L (mm)	381 × 1,450	381 × 1,450	381 × 1,450
Baking area m <sup>2</sup>	0.34	0.69	1.03
Internal height mm	85	85	85
Max temp. °C	400	400	400
Baking time minutes*	2-15	2-15	2-15
Power kW	9.5	18.5	28.5
Weight (kg)	160	275	390

	<b>TP11 - 1 deck</b>	<b>TP21 - 2 decks</b>	<b>TP31 - 3 decks</b>
Conveyor W × L (mm)	585 × 1,750	585 × 1,750	585 × 1,750
Baking area m <sup>2</sup>	0.53	1.06	1.59
Internal height mm	90	90	90
Max temp. °C	400	400	400
Baking time minutes*	2-15	2-15	2-15
Power kW	12	24	36
Weight (kg)	240	380	510

	<b>TP12 - 1 deck</b>	<b>TP22 - 2 decks</b>	<b>TP32 - 3 decks</b>
Conveyor W × L (mm)	900 × 1,750	900 × 1,750	900 × 1,750
Baking area m <sup>2</sup>	0.81	1.62	2.44
Internal height mm	90	90	90
Max temp. °C	400	400	400
Baking time minutes*	2-15	2-15	2-15
Power kW	18	36	54
Weight (kg)	300	475	650

\* Prebaking is not necessary and is therefore not included in the baking time.

**We believe in high performing, energy efficient and user-friendly equipment.**

We offer reliable technology that allows the professionals of the baking industry creative freedom at the lowest cost of ownership.

We become the professional business partner throughout the baking process, with an accessible organization, user-friendly designs and precisely controlled, reliable equipment.

**Sveba Dahlen AB**  
Industrivägen 8  
SE-513 82 Fristad  
[www.sveba-dahlen.com](http://www.sveba-dahlen.com)  
[info@sveba-dahlen.se](mailto:info@sveba-dahlen.se)

